

AI, anestrus, anovulatory, CO-Synch, corpus luteum, CIDR, Cystorelin, cyclicity, dominant follicle, estrus, estrous cycle, estradiol, estrogen, ECP, eCG, embryo, Estrumate, Estroplan, Factrel, Fertagyl, fertility, fixed-timed AI, Follicle Stimulating Hormone, follicular wave, FSH, Gonadotropin Releasing Hormone, GnRH, insemination, heat detection, In-Synch, LH, Lutalyse, lutenization, Luteinizing hormone, melengestrol acetate, MGA, regression, Select Synch, TAI, FTAI, EAI, ovary, ovulation, OvaCyst pregnancy, progestin, prostaglandin F2 α , Prostamate, postpartum, prepubertal, preovulatory, AI, anestrus, anovulatory, CO-Synch, corpus luteum, CIDR, Cystorelin, cyclicity, dominant follicle, estrus, estrous cycle, estradiol, estrogen, ECP, eCG, embryo, Estrumate, Estroplan, Factrel, Fertagyl, fertility, fixed-timed AI, Follicle Stimulating Hormone, follicular wave, FSH, Gonadotropin Releasing Hormone, GnRH, insemination, heat detection, In-Synch, LH, Lutalyse, lutenization, Luteinizing hormone, melengestrol acetate, MGA, regression, Select Synch, TAI, FTAI, EAI, ovary, ovulation, OvaCyst, pregnancy, progestin, prostaglandin F2 α , Prostamate, postpartum, prepubertal, preovulatory.

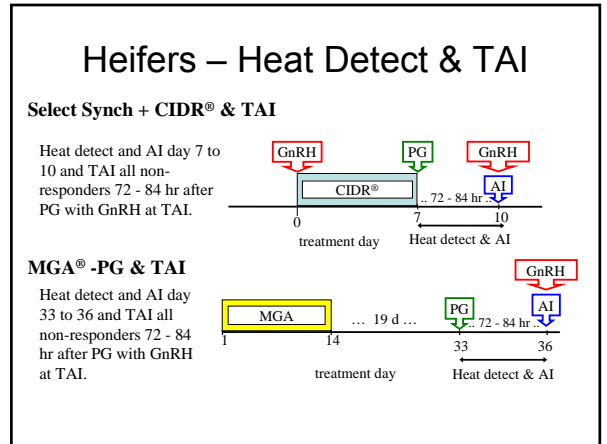
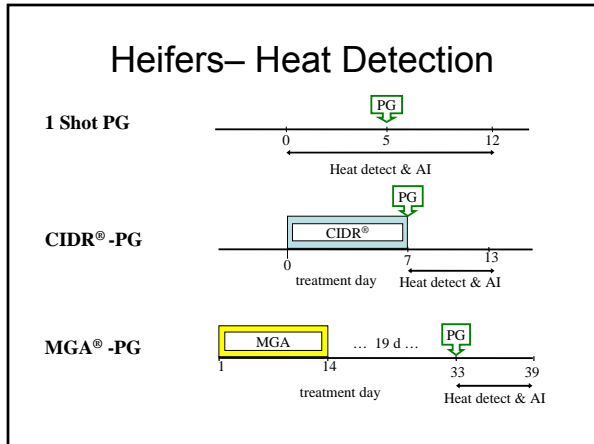
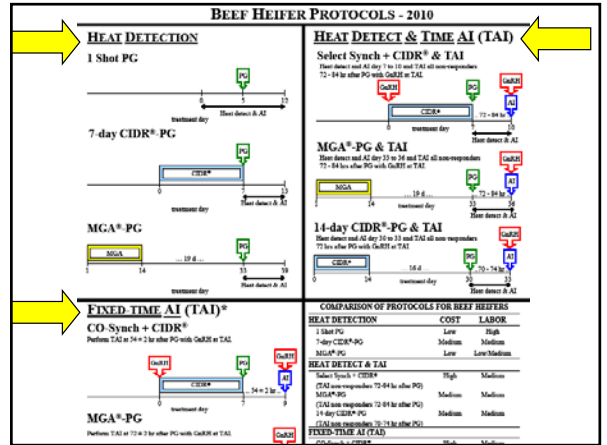
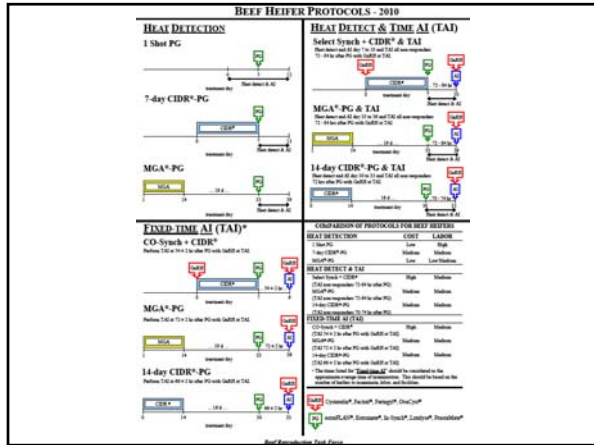

Heifers – Heat Detect & TAI

14-day CIDR®-PG & TAI

Heat detect and AI day 30 to 33 and TAI all non-responders 70 - 74 hr after PG with GnRH at TAI.

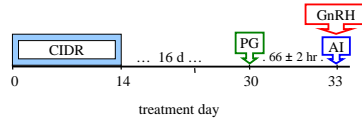

Heifers – Fixed-Time AI (TAI)

CO-Synch + CIDR®

Perform TAI at 54 ± 2 hr after PG with GnRH at TAI.

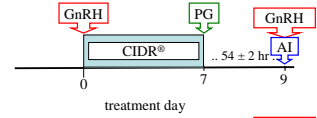

MGA® -PG

Perform TAI at 72 ± 2 hr after PG with GnRH at TAI.

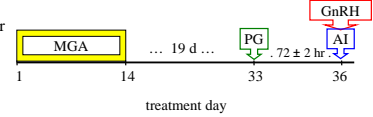

14-day CIDR®-PG

Perform TAI at 66 ± 2 hr after PG with GnRH at TAI.

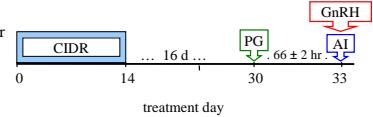

BEEF COW PROTOCOLS - 2010	
HEAT DETECTION Select Synch Select Synch + CIDR® 	HEAT DETECT & TIME AI (TAI) Select Synch & TAI Select Synch + CIDR® & TAI
FIXED-TIME AI (TAI)* 7-day CO-Synch + CIDR® 5-day CO-Synch + CIDR® 	FIXED-TIME AI (TAI)* 7-day CO-Synch + CIDR® 5-day CO-Synch + CIDR®

Cows – Heat Detection

Select Synch

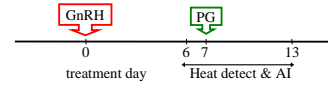

Select Synch + CIDR®

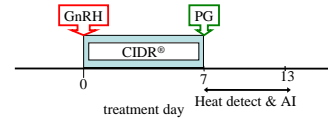

Cows – Heat Detect & TAI

Select Synch & TAI

Heat detect and AI day 4 to 10 and TAI all non-responders 72 - 84 hr after PG with GnRH at TAI.

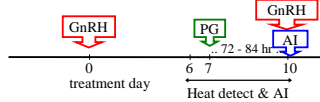

Select Synch + CIDR® & TAI

Heat detect and AI day 7 to 10 and TAI all non-responders 72 - 84 hr after PG with GnRH at TAI.

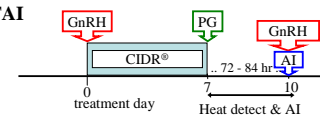

Cows – Fixed-Time AI (TAI)

CO-Synch + CIDR®

Perform TAI at 60 to 66 hr after PG with GnRH at TAI.

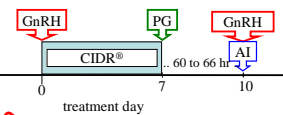

2007 version

7-day CO-Synch + CIDR® - Cows

Perform TAI at 60 - 66 hr after PG with GnRH at TAI.

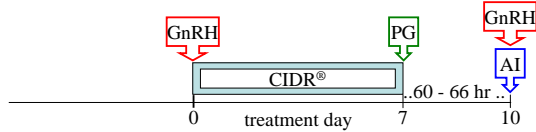

5-day CO-Synch + CIDR®

Two injections of PG 8 ± 2 hr apart are required for this protocol. Perform TAI at 72 ± 2 hr after 1st PG with GnRH at TAI.

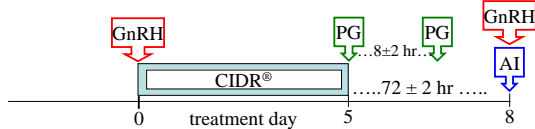

Products

GnRH Cystorelin®, Factrel®, Fertagyl®, OvaCyst®

PG Estrumate®, In-Synch®, Lutalyse®, ProstaMate®, estroPLAN®

- Make sure to give the correct injection on the day specified in the protocol
- Within product category, all products are equally effective
- Use at label dose
- Follow BQA guidelines for all injections

Estrus Synchronization Planner



Features

- Recommended systems for cows & heifers
- Select systems by type
 - Heat detect & AI systems
 - Heat detect & cleanup AI systems
 - Fixed-Timed AI Systems
- List of daily activities
- Generates Barn Calendar
- Cost per AI pregnancy
- Support materials

